



Teepee 10,5x10,5





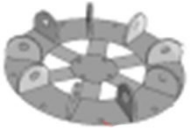
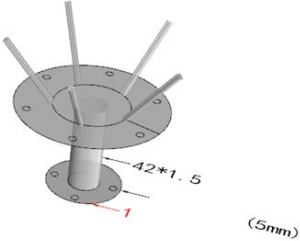

Assembly guide

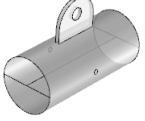

zederkof
hvor mennesker mødes

TEEPEE 10,5x10,5 packing list

Item	Size /mm	Qty	Mark
1# pole	4250	9 pcs	Inclined beam (up), ϕ 80mm
2# pole	1650	9 pcs	Beam, ϕ 80mm
3# pole	3650	9 pcs	Beam, ϕ 80mm
4# pole	2145	11 pcs	Support, ϕ 80mm
5# pole	2000	2 pcs	For door, ϕ 80mm
6# pole	3600	1 pc	For door, ϕ 80mm
7# pole	3750	9 pcs	Inclined beam (down), ϕ 105mm
8# pole	800	5 pcs	On the top, ϕ 50mm
Self-tapping screw	M8*60	70 pcs	Fix bases on platform
Self-tapping screw	M4*35	190 pcs	
Stainless screw	M18*55	18 pcs	
Stainless screw	M16*200	18 pcs	
Stainless screw	M8*30	11 pcs	With 36 washers and 12 rubber rings
M6 Screw	M6*45	280 pcs	For wood pole

Tighter		10 pcs	
Self-tapping screw socket		1 pc	For M8 screws
Self-tapping screw socket		1 pc	For M6 screws
Ground anchor	M10*500	9 pcs	
8# black rubber band		3 pcs	7m length, with hook
1# plate		1 pc	The bottom of the 1# connect plate, with the lugs facing downward, is used to fix the 1# poles
1# connector		1 pc	At inside of roof top
1# flange		1 pc	Press roof on 1# connector outside

2# connector		18 pcs	
3# connector		9 pcs	
4# connector		9 pcs	
5# & 6# connector		1 pair	
7# connector		1 pc	
8# connector		1 pc	
9# connector		9 pcs	Base
10# connector		2 pcs	Base

2.5cm width webbing	800 lengths	10 pcs	
Pull ring for fixing		12 pcs	
8# khaki rope	5000 lengths	9 pcs	
8# khaki rope	25000 lengths	3 pcs	fix side panel
4# khaki rope	8000 lengths	3 pcs	
Webbing	2800 lengths	3 pcs	With buckle
Webbing	1500 lengths	3 pcs	
Top hat		1 pc	
Cover cloth		1 pc	

Side panel packing list

Item	Size /mm	Qty	Mark
Side panel support	2000	7 pcs	Wood pole
2# connector		7 pcs	
3# connector		7 pcs	
10# connector		7 pcs	
Self-tapping screw	M8*60	45 pcs	
Stainless screw	M18*55	8 pcs	
M6 Screw	M6*50	42 pcs	For wood pole
Self-tapping screw socket		1 pc	For M8 screws
Self-tapping screw socket		1 pc	For M6 screws

Drilling screw	M5.5*25	140 pcs	
8# khaki rope		120 meters	
Clear side panel		1 set	3 pcs

The overall effect diagram is as follows



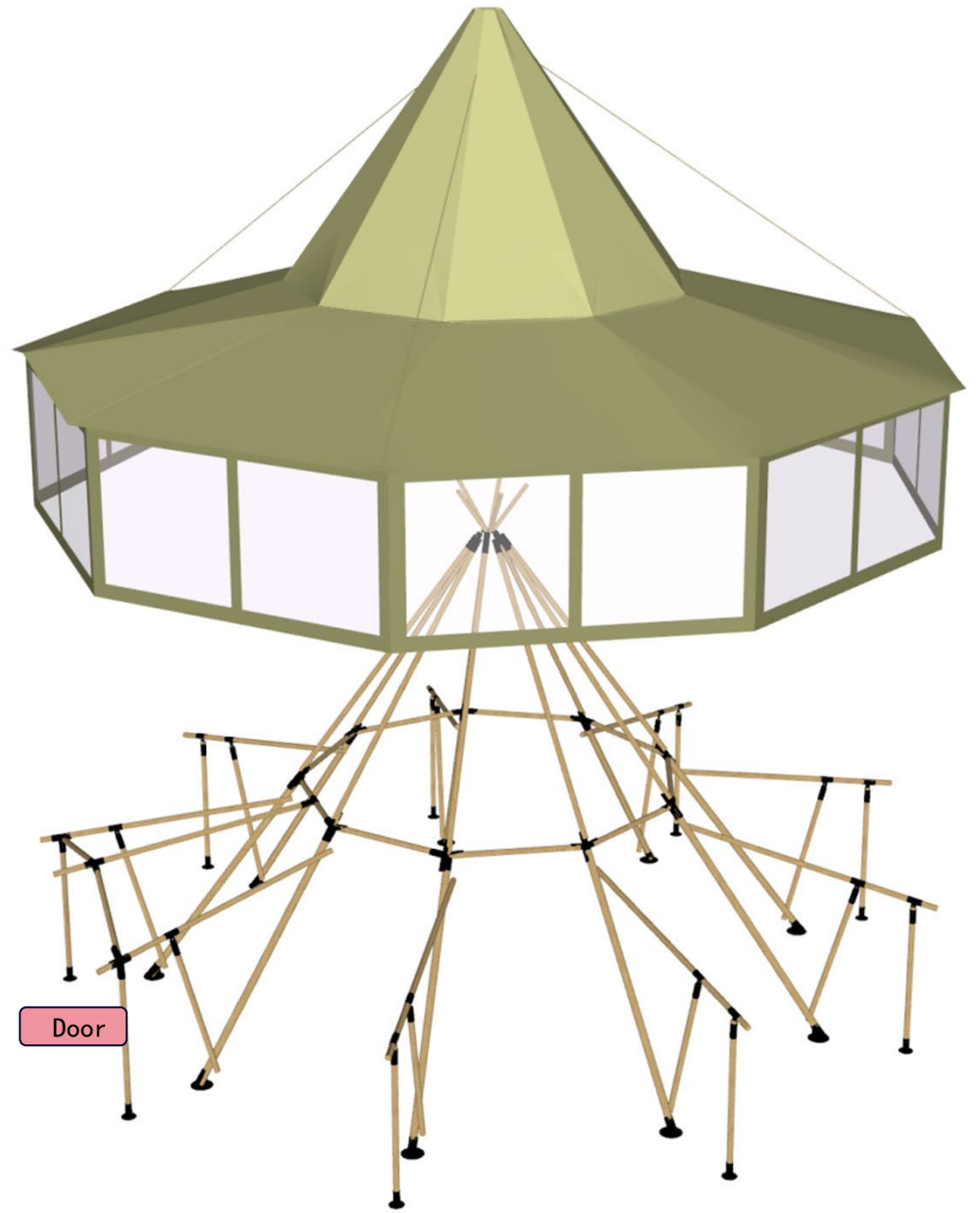
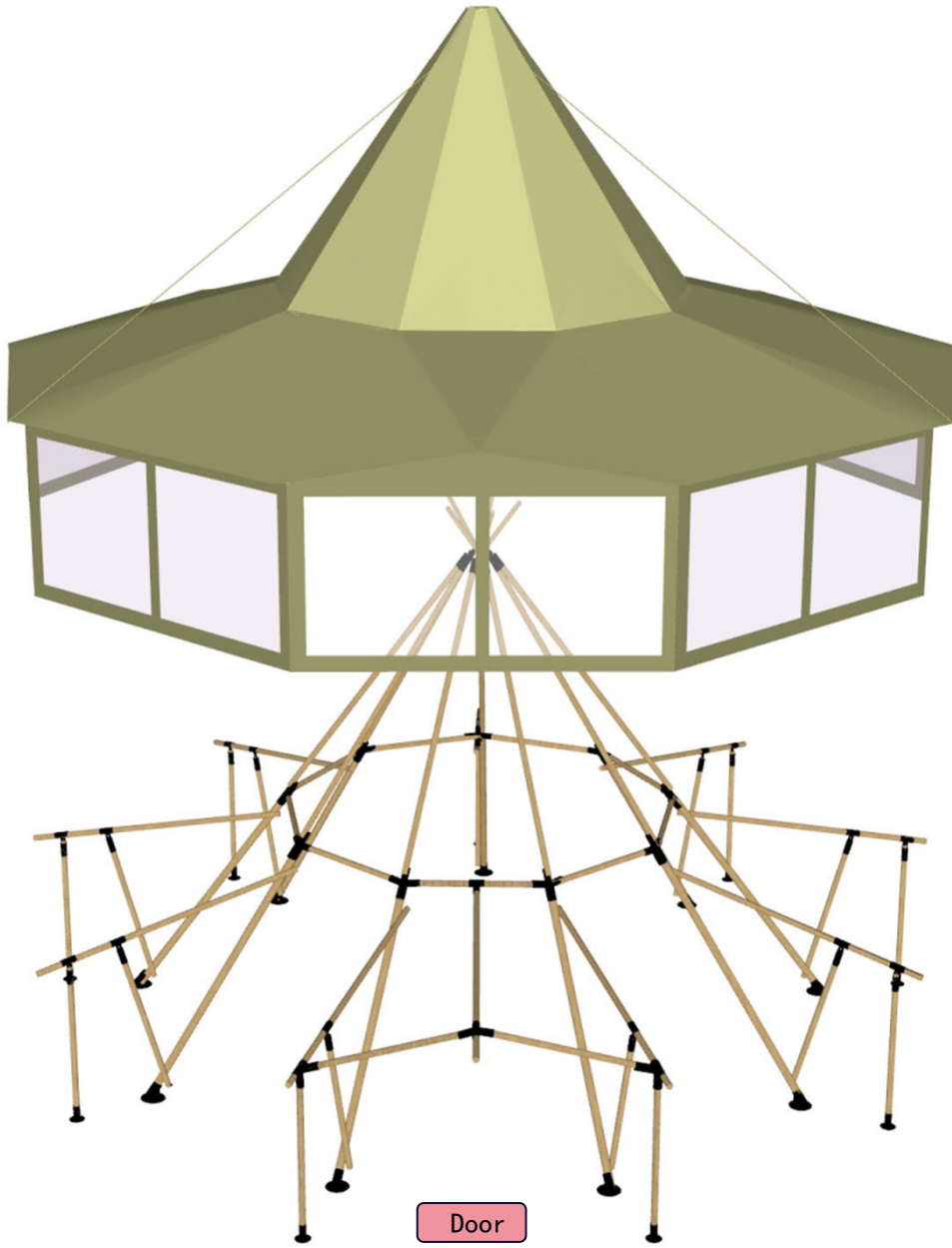

The TEEPEE tent consists of two parts as shown below

- Cover cloth/frame:

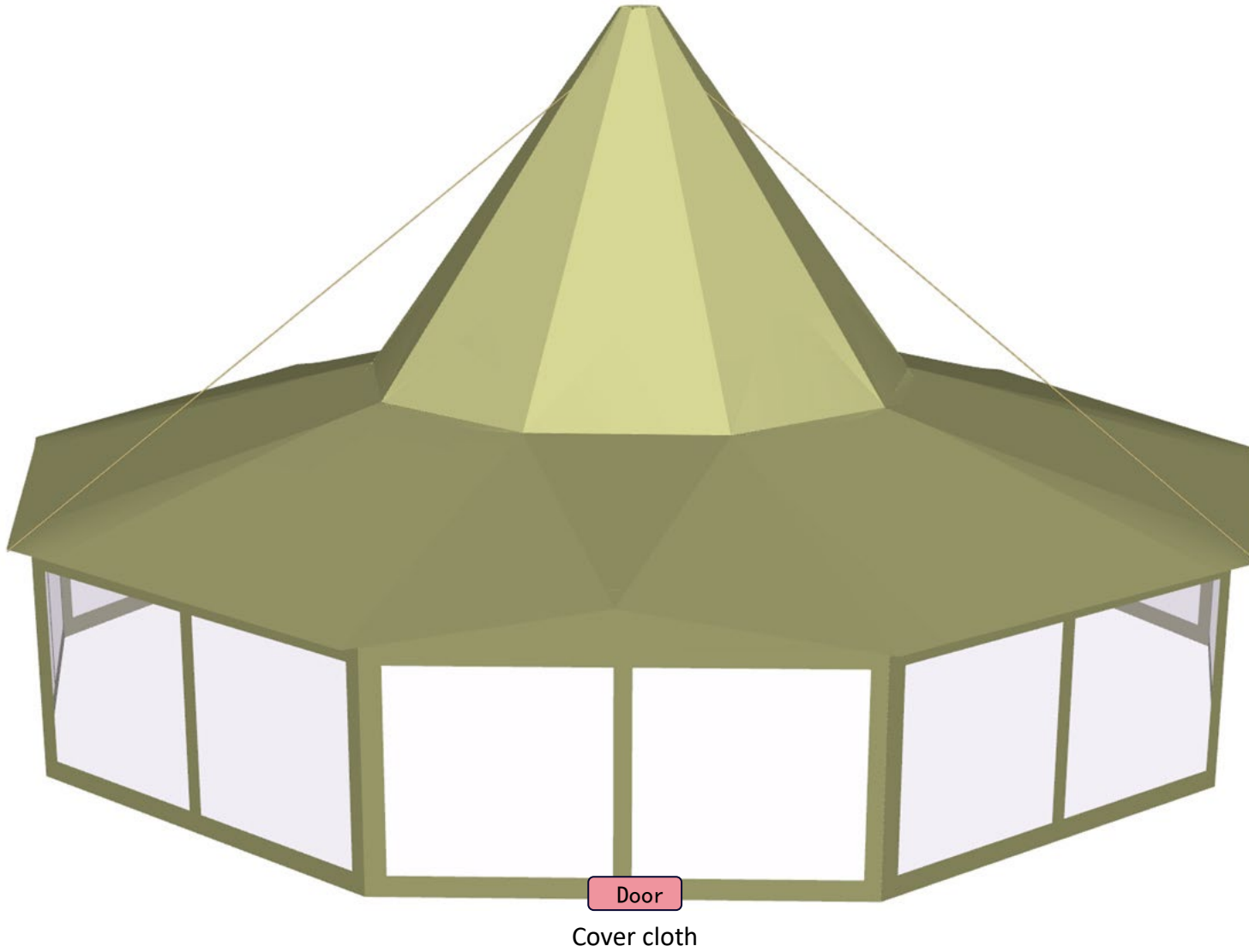

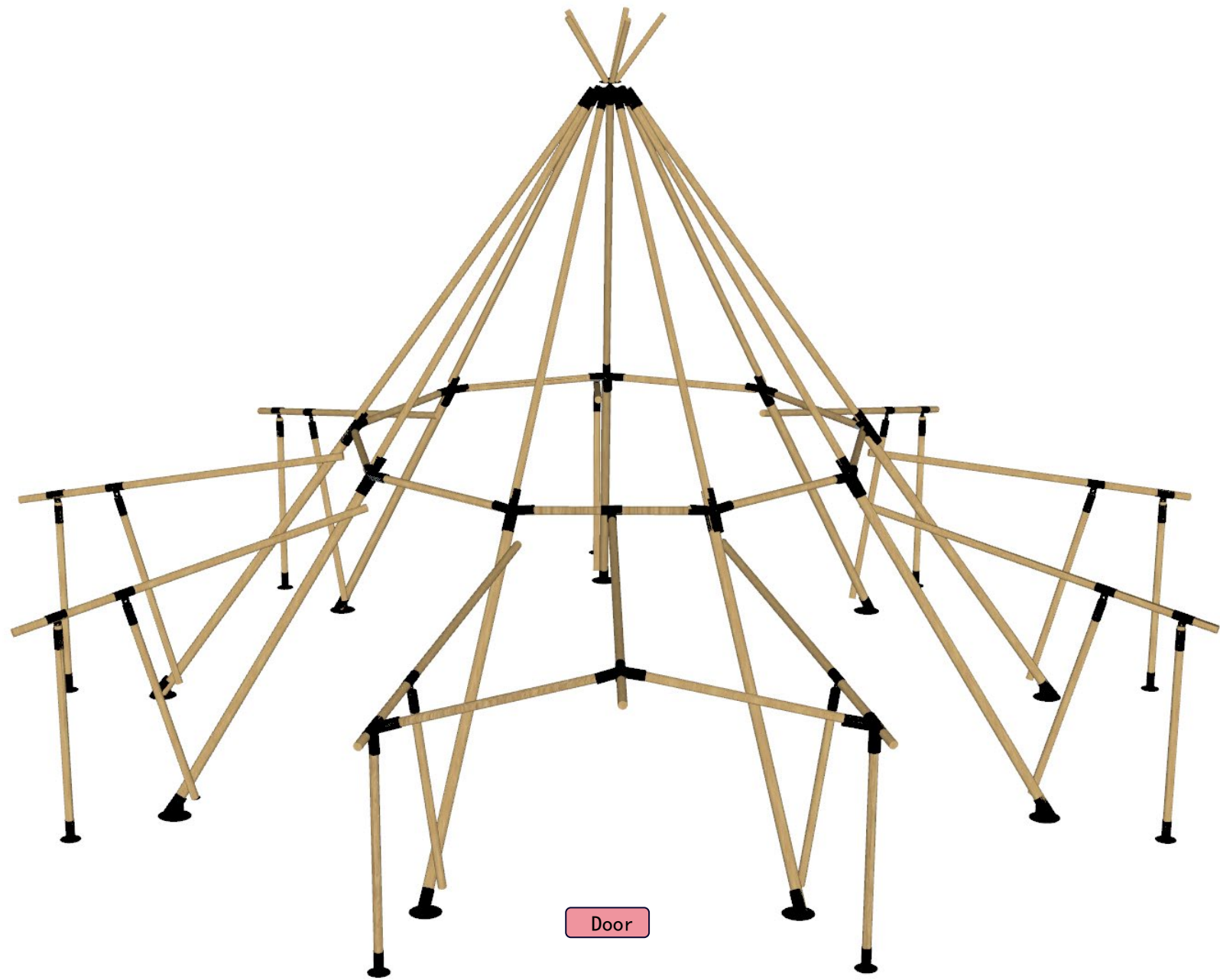

Door

Frame

The installation steps are as follows:

- Frame poles rendering:

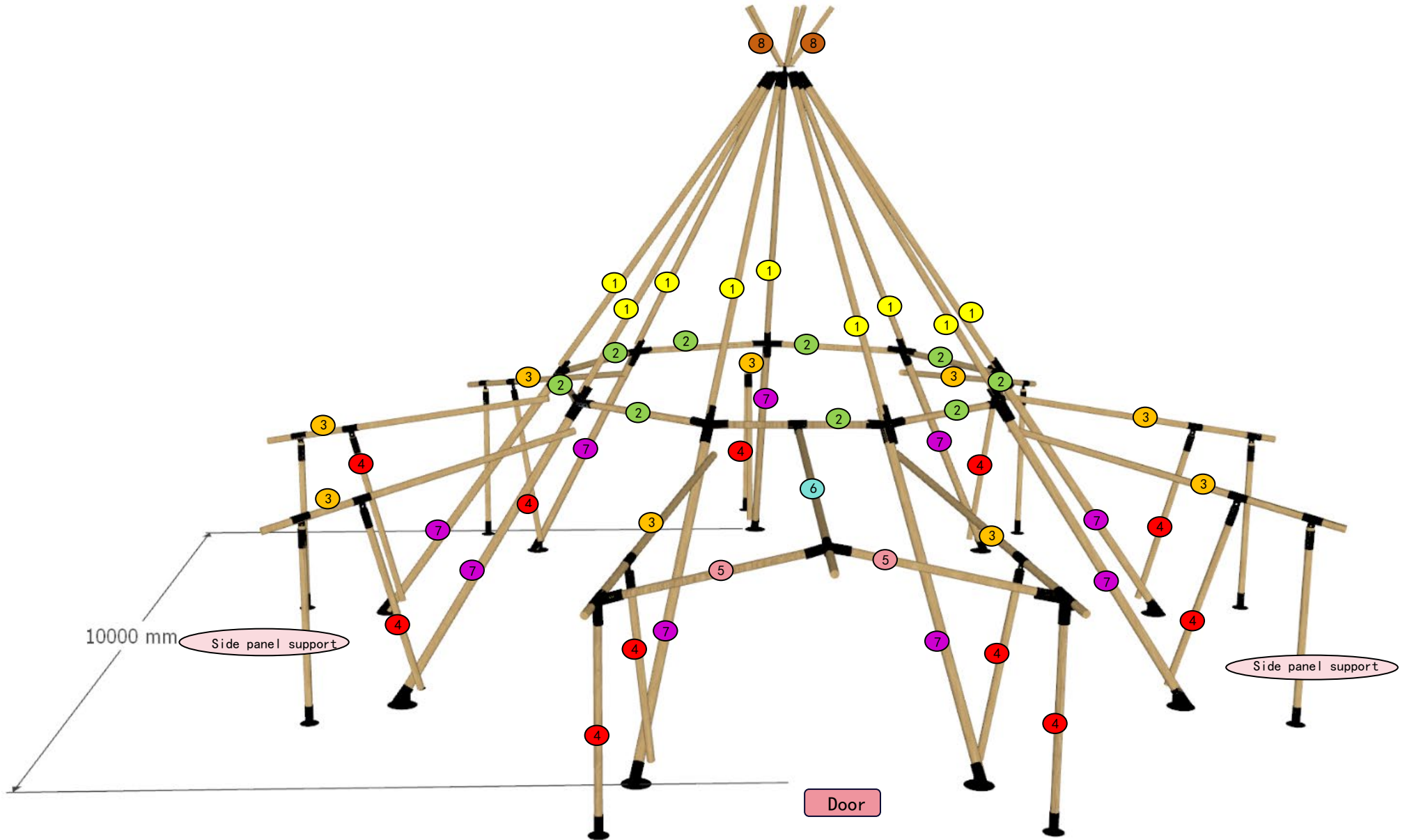

● Frame connect plates rendering:

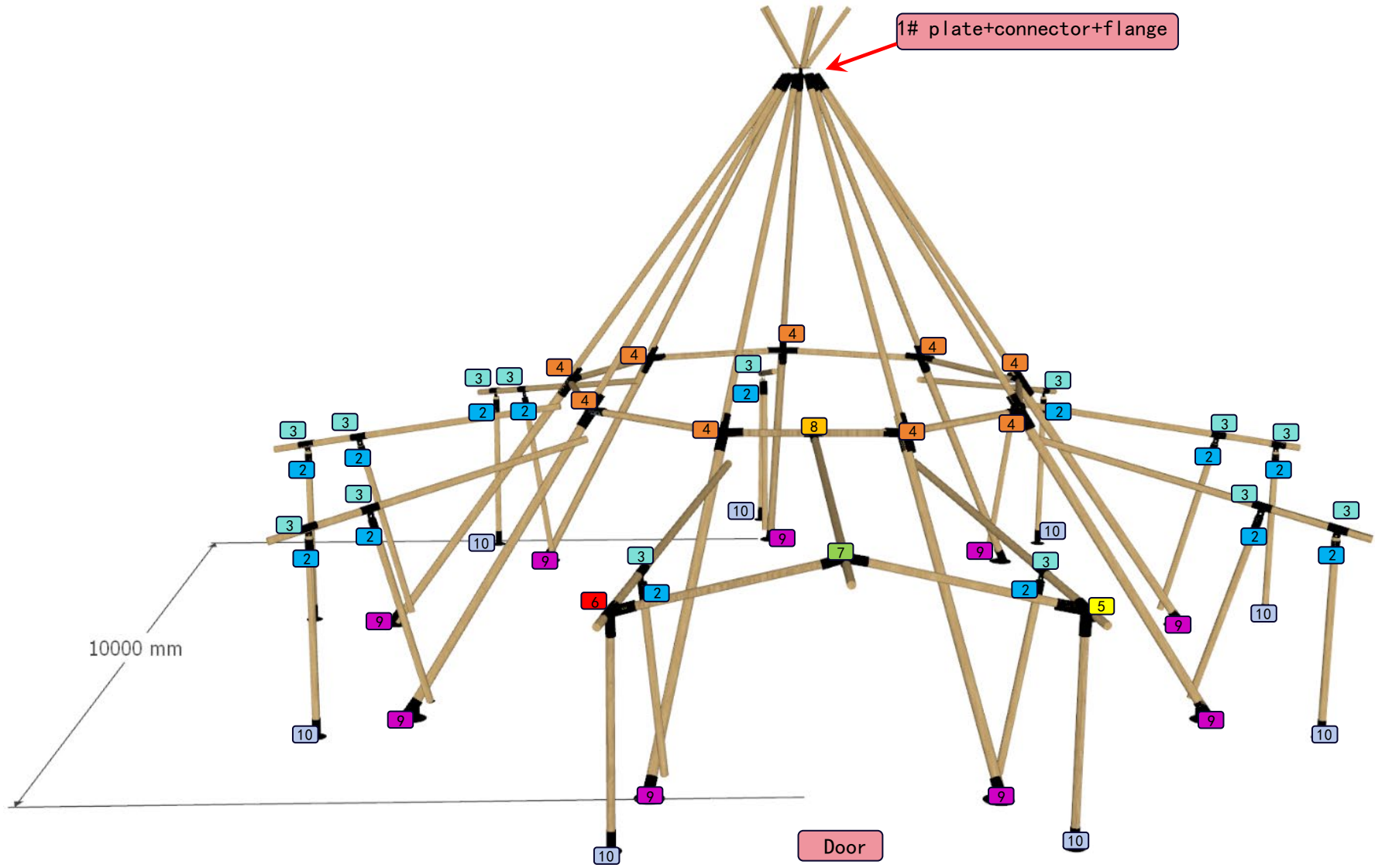

Step 1: Confirm the location of the tent bases according to the dimensions shown in the figure, as shown below:

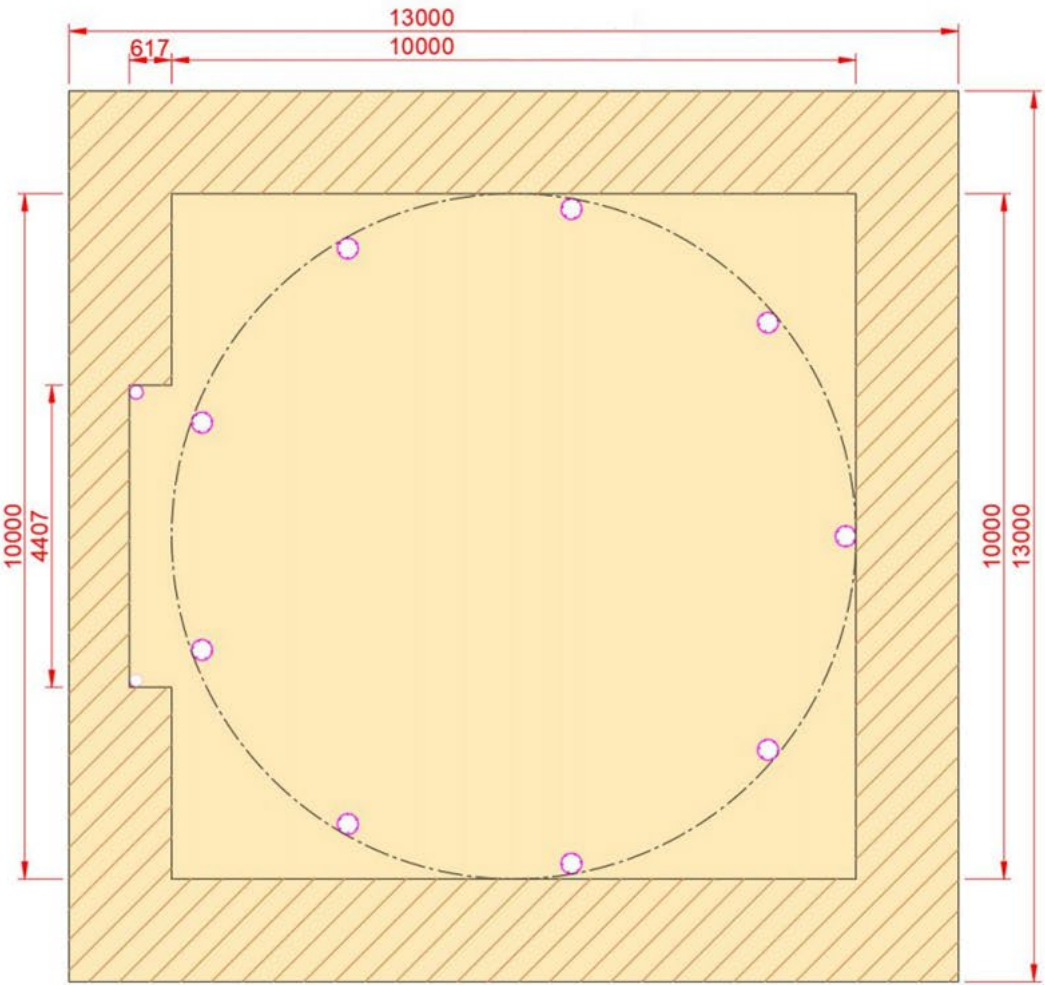

Platform

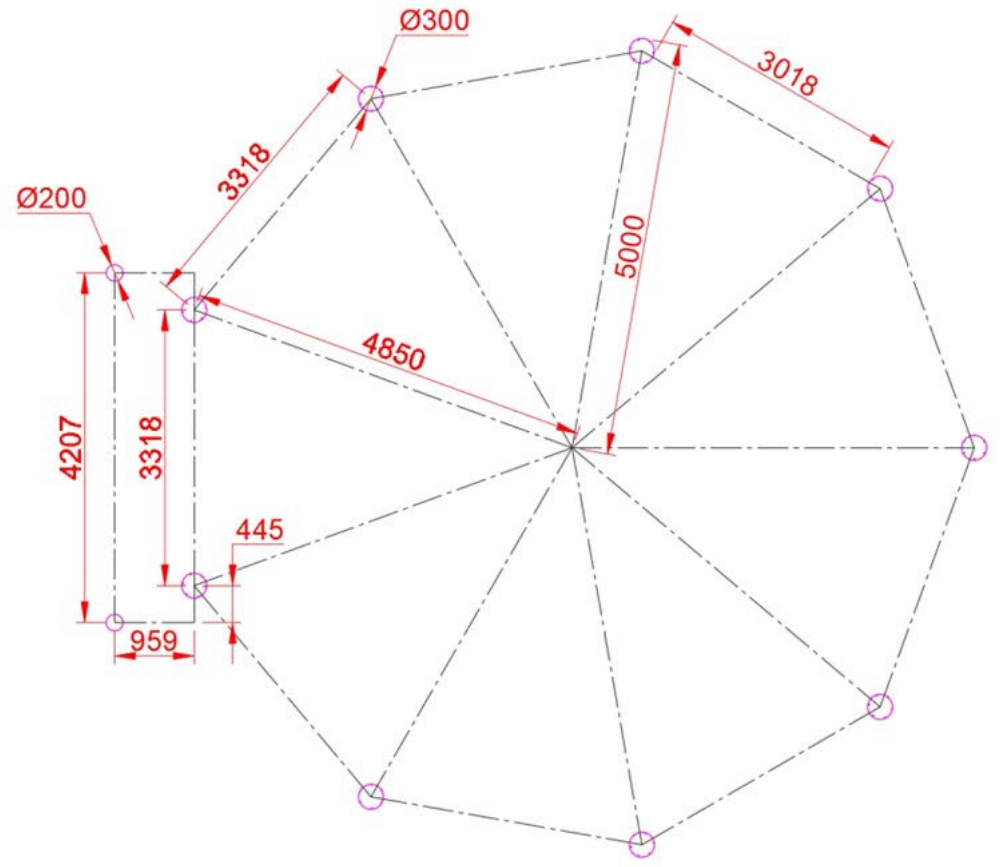

base

Step 2: Assemble the 1# plate and 2# connector (9 in total), and fix with M18*55 stainless screws; then insert 1# poles into 2# connectors (9 in total) and fix with M6 screws, as shown below:

1# plate

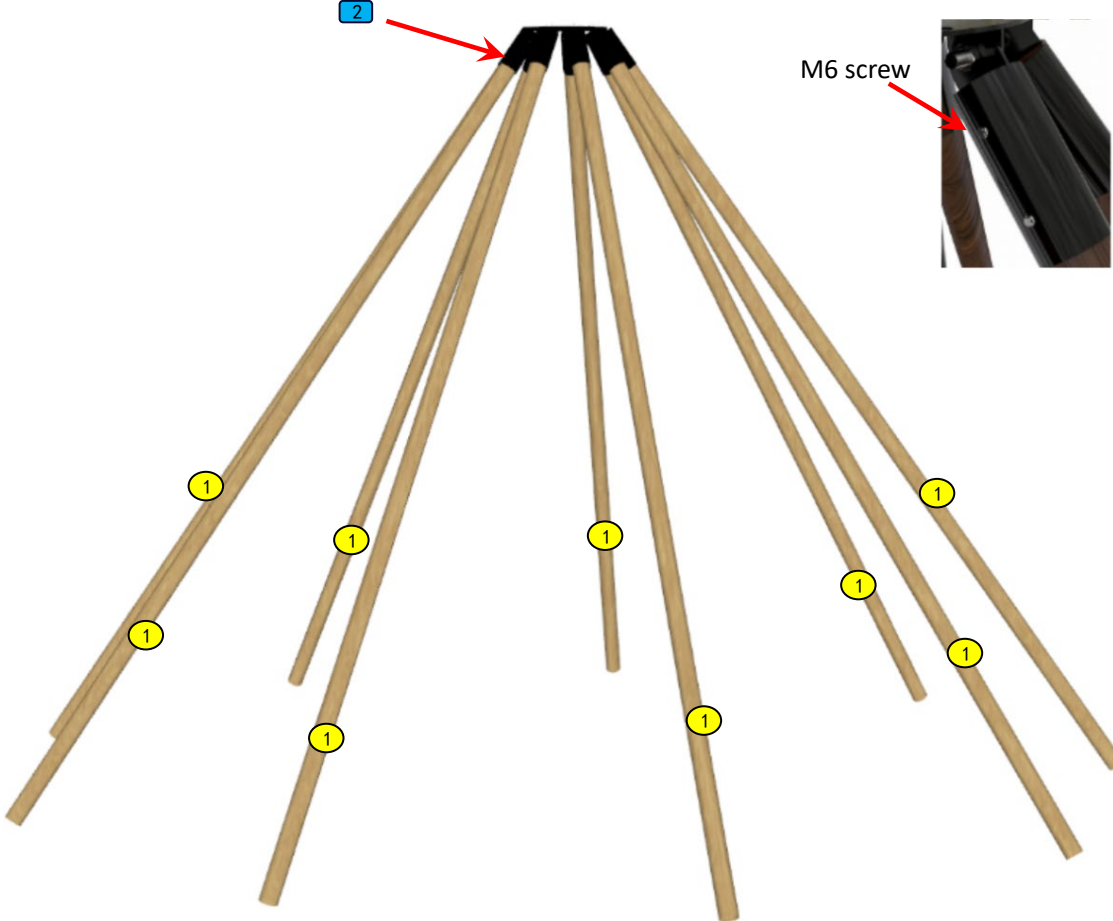
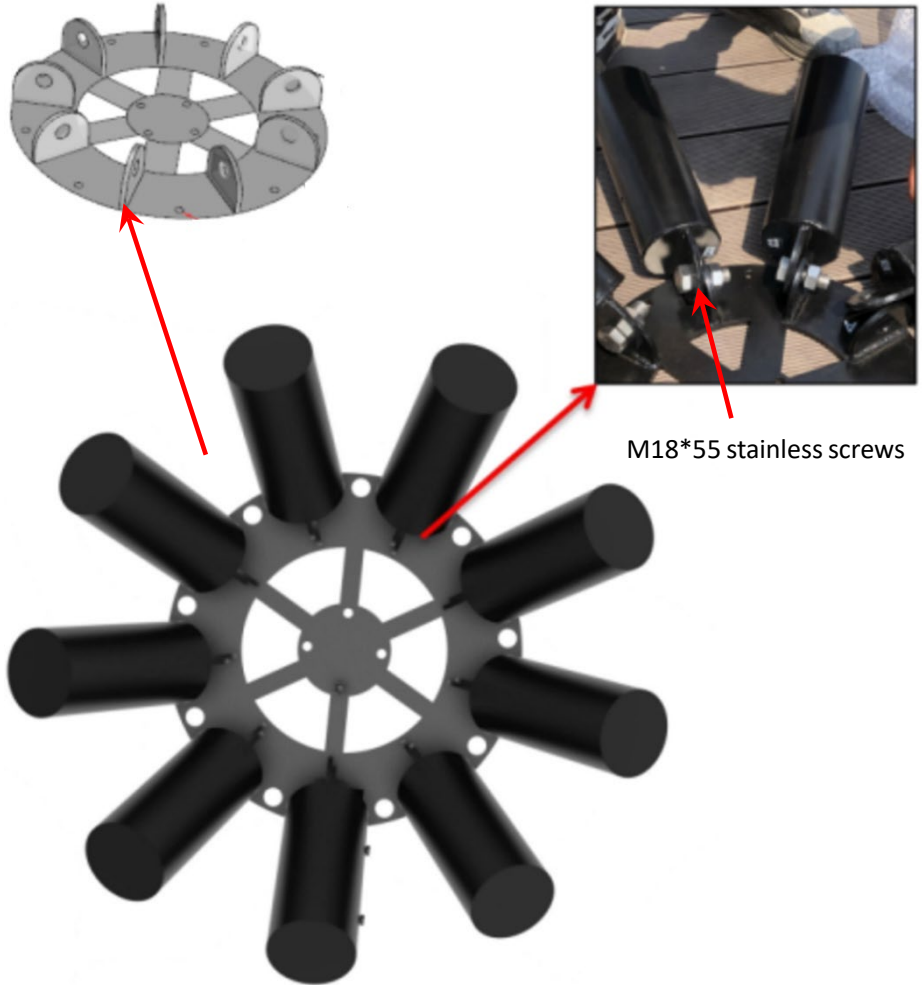

Step 3. Insert 4# connector into the 1# poles (9 in total) and fix it with M6 screws; then insert both ends of the 2# poles into the 4# connectors by 10cm, so that the center-to-center distance of the 4# connector at both ends is 1770mm, and the inner side-to-side distance of the connector is 1490mm (9 in total), and fix it with M6 screws; Note: At the front door position, **insert the 8# connector into the 2# pole(for door frame)** and then connect and fix the two ends with the 4# connectors, as shown in the figure below:

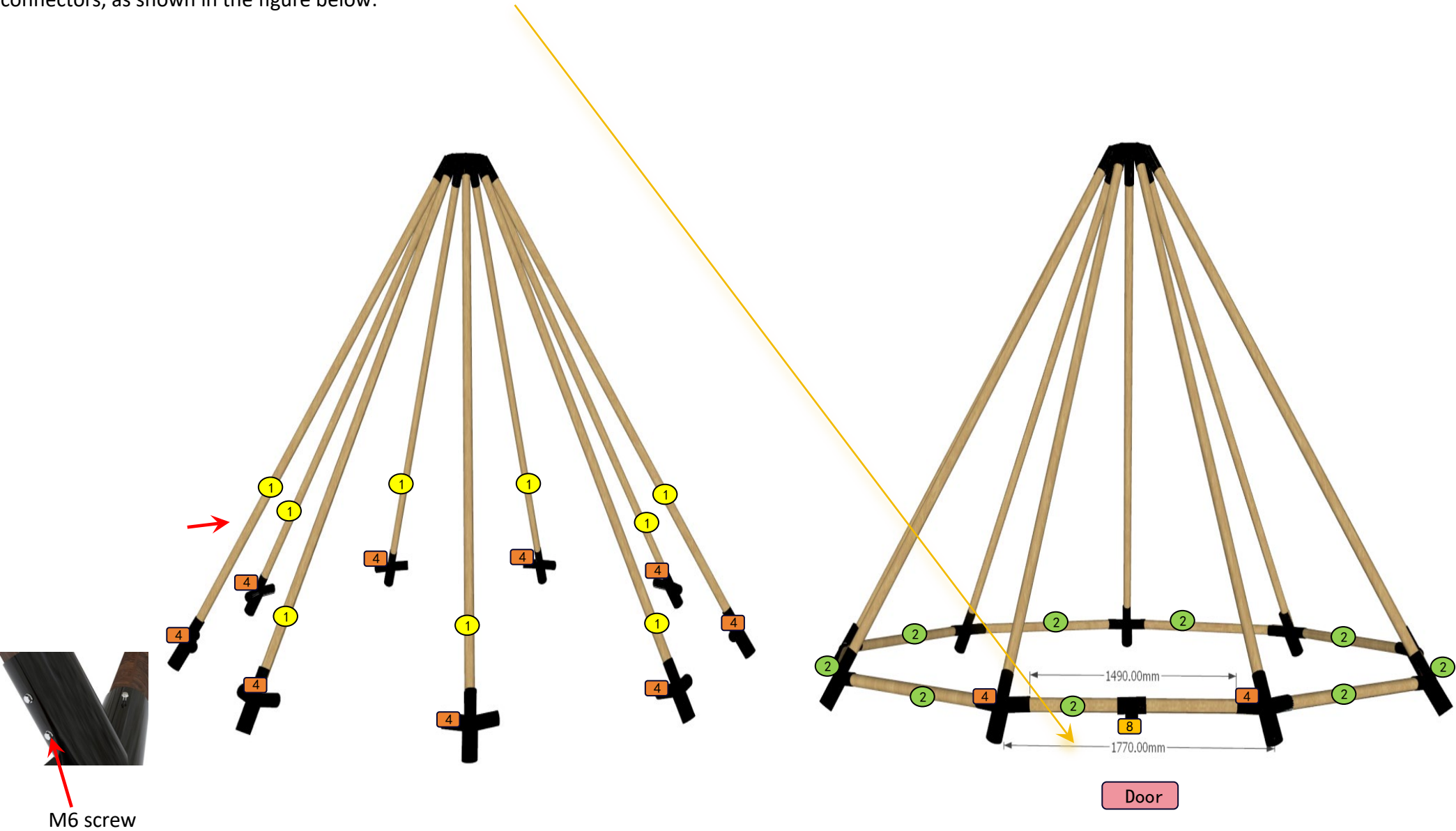

M6 screw

Step 4. Insert one end of the 7# pole into the 4# connector and the other end into the 9# connector. Fix it with M6 screws. Then use M8*60 self-tapping screws to fix the 9# connectors to the platform (refer to the tent foot size diagram in step 1 for the position). If using a crane to install, the cover cloth can be hung on the upper frame at the same time. After the 9# connectors are fixed, put the cloth down, as shown below:

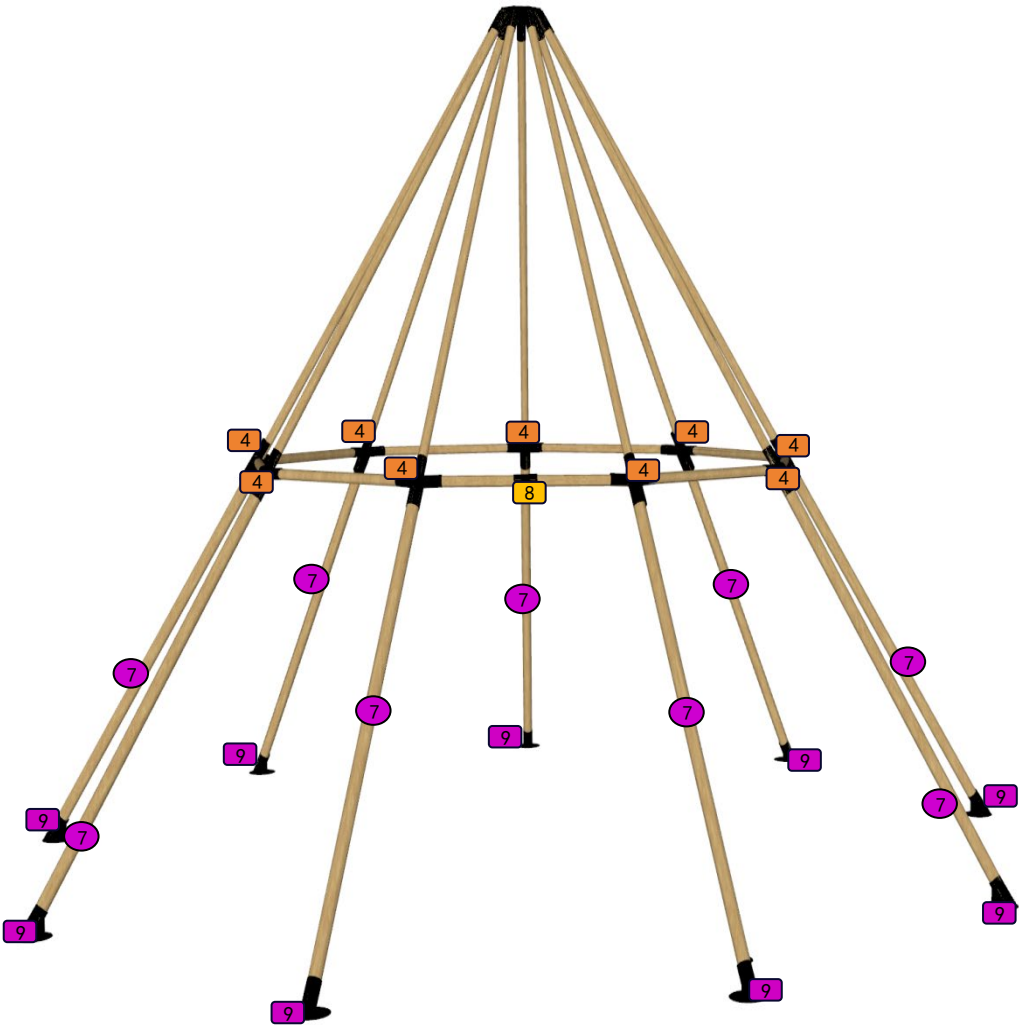

9# connector

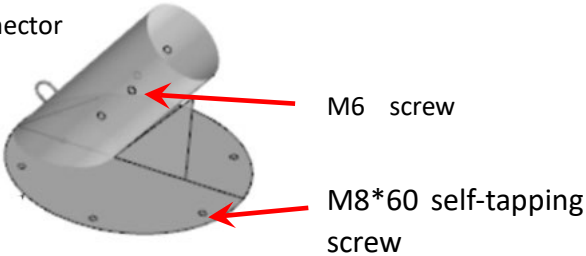

Step 5. Fix the 3# poles to the 7# poles with M16*200 stainless screws, insert the 3# connectors into the 3# poles, fix it with M6 screws 1000mm from the end of the 3# poles, and install the tighter on the end slot; then insert the 2# connectors into the end without hole of the 4# poles, fix it with M6 screws, connect the 2# and 3# connectors, fix them with M18*55 stainless screws, and fix the 4# poles and the 7# poles with M16*200 stainless screws, as shown below:

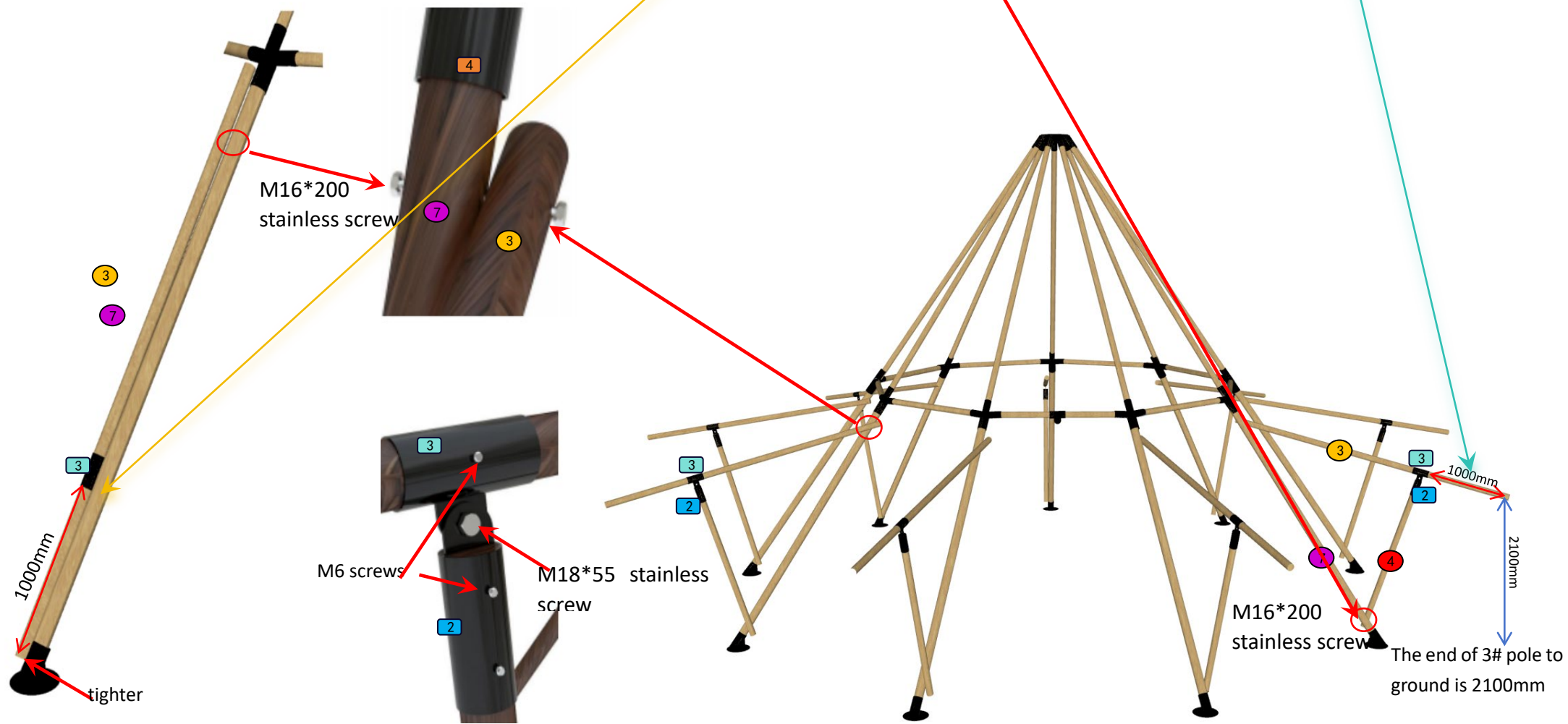

Step 6. **Insert the 5# and 6# connectors 150mm from the end of the 3# poles and fix them with M6 screws;** insert the 10# connectors into the end of the 4# poles and fix it with M6 screws, and fix it with M8*60 self-tapping screws at the intersection with the platform; insert one end of the 6# poles into the 8# connector and fix it with M6 screws, and **insert the other end into the 7# connector and fix it with M6 screws at 440mm from the end of the 6# pole;** connect the No. 5, 7, and 6 connectors with two 5# poles and fix them with M6 screws, as shown below:

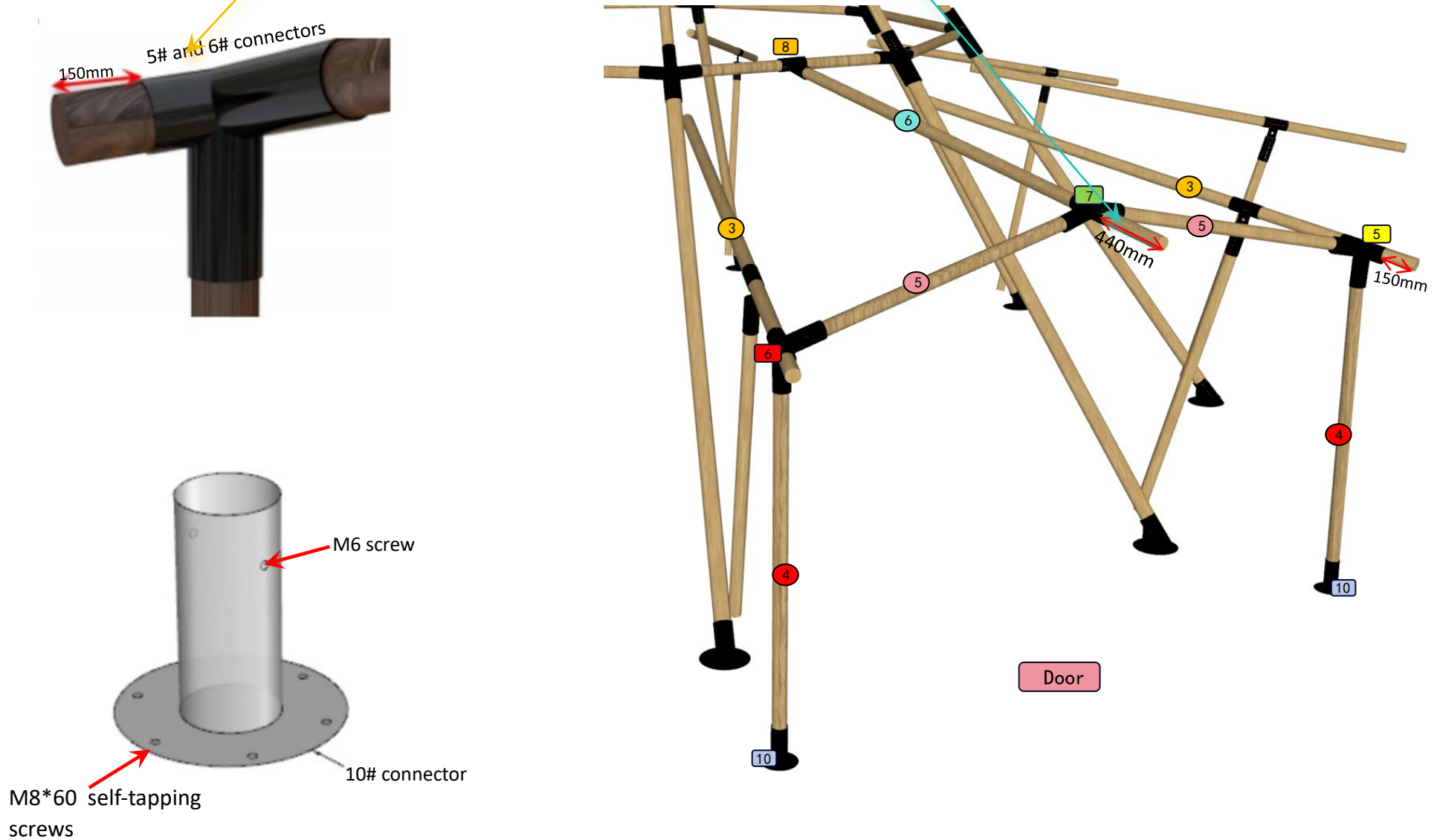

Step 7. Insert the 3# connectors 150mm away from the end of the 3# pole and fix it with M6 screws; insert the 2# connector into the top of the side panel support and fix it with the 3# connector with M18*55 stainless screws; insert the 10# connectors into the side panel support and fix it on platform with M8*60 self-tapping screws (7 places in total), as shown below:

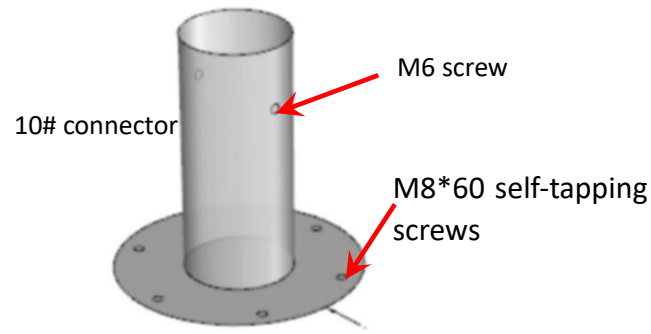
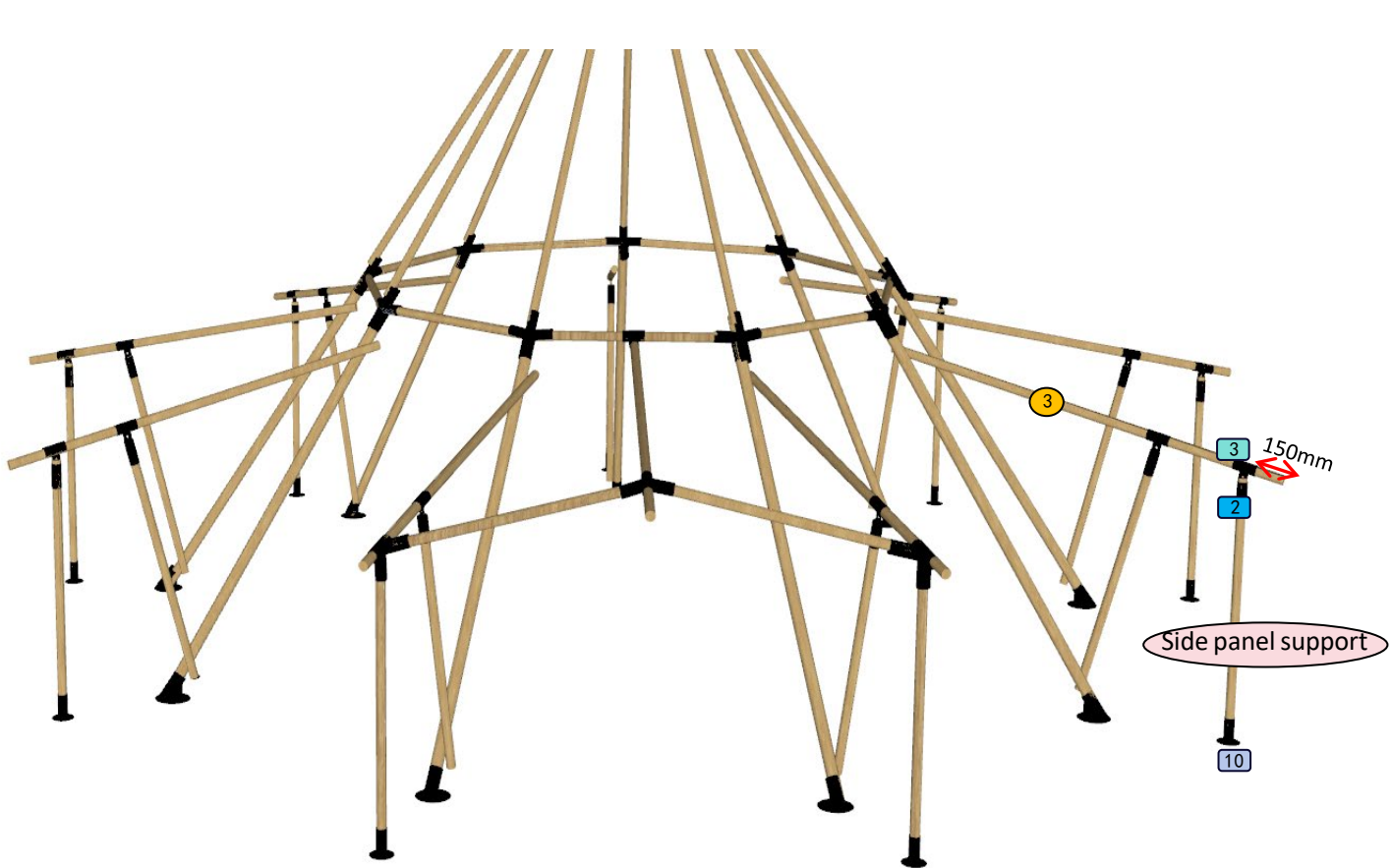

Step 8. First, put the top hat on the top and fix it on the 1# connector with inside straps. Fix the 1# flange to the 1# connector with M8*30 stainless screws. Note that the screws up the flange should use rubber rings and washers, and the nuts with washers at below. Finally, screw in 5 pcs 8# poles on the top, as shown below:

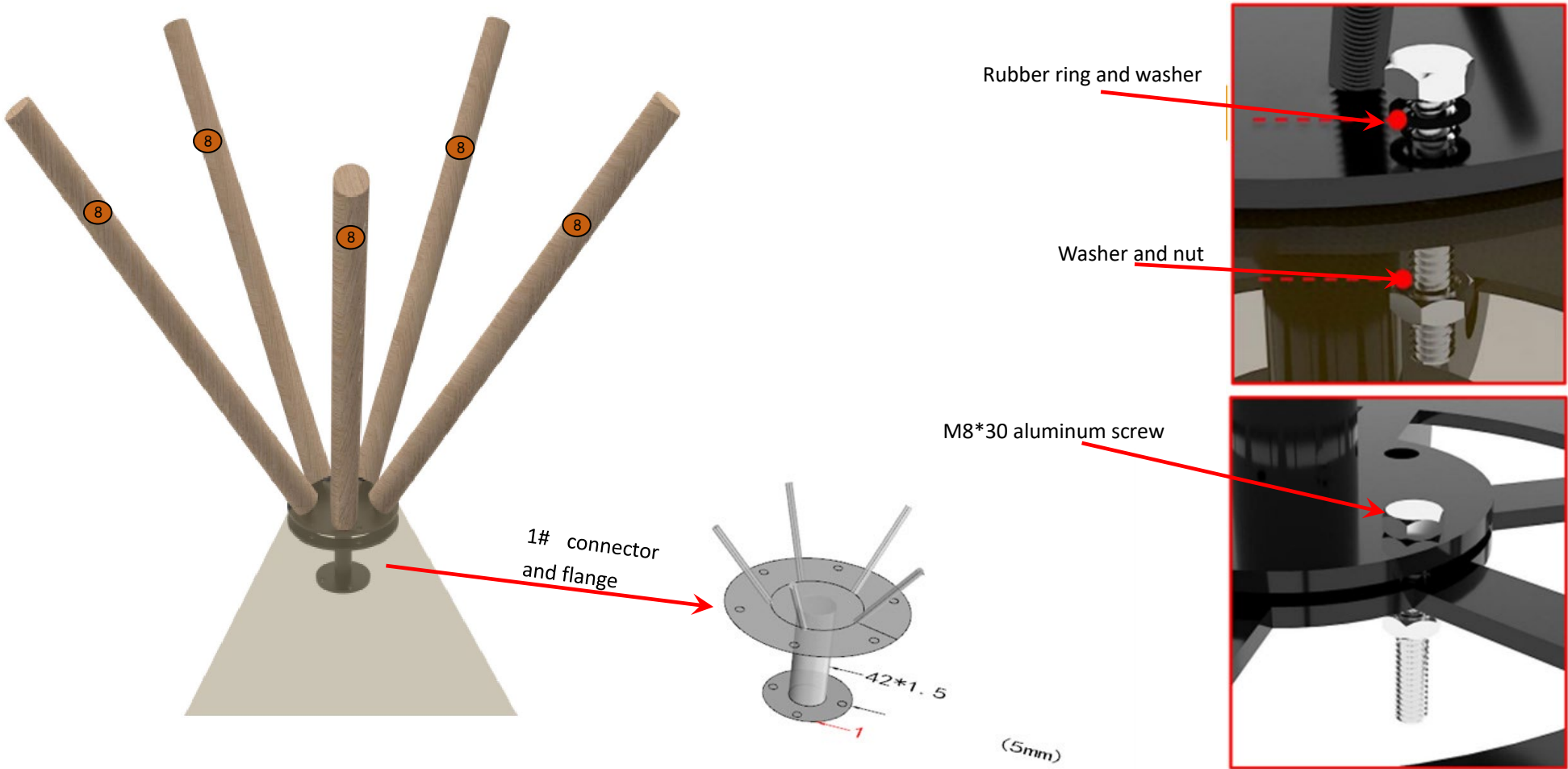

- **Cover cloth:**

Step 1. Pull the cover cloth onto the frame and spread it out. Use the buckle webbing inside of cloth to fix the cloth on frame from top to bottom (fix the lower buckle webbing after adjusted tighteners at the end of 3# poles), as shown below:

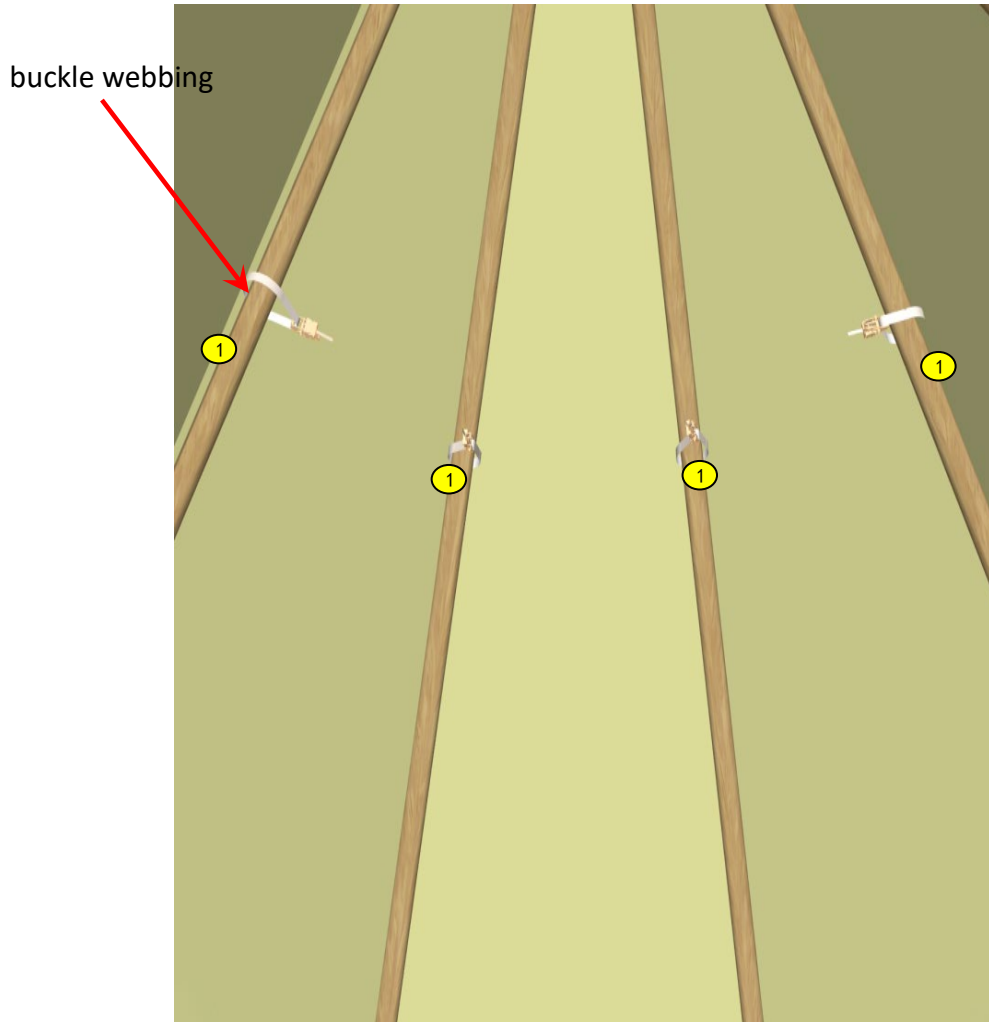

Lower buckle webbing

Step 2 is the same as frame install step 8 to install top hat, as shown below:

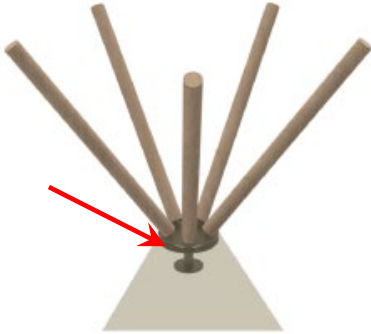
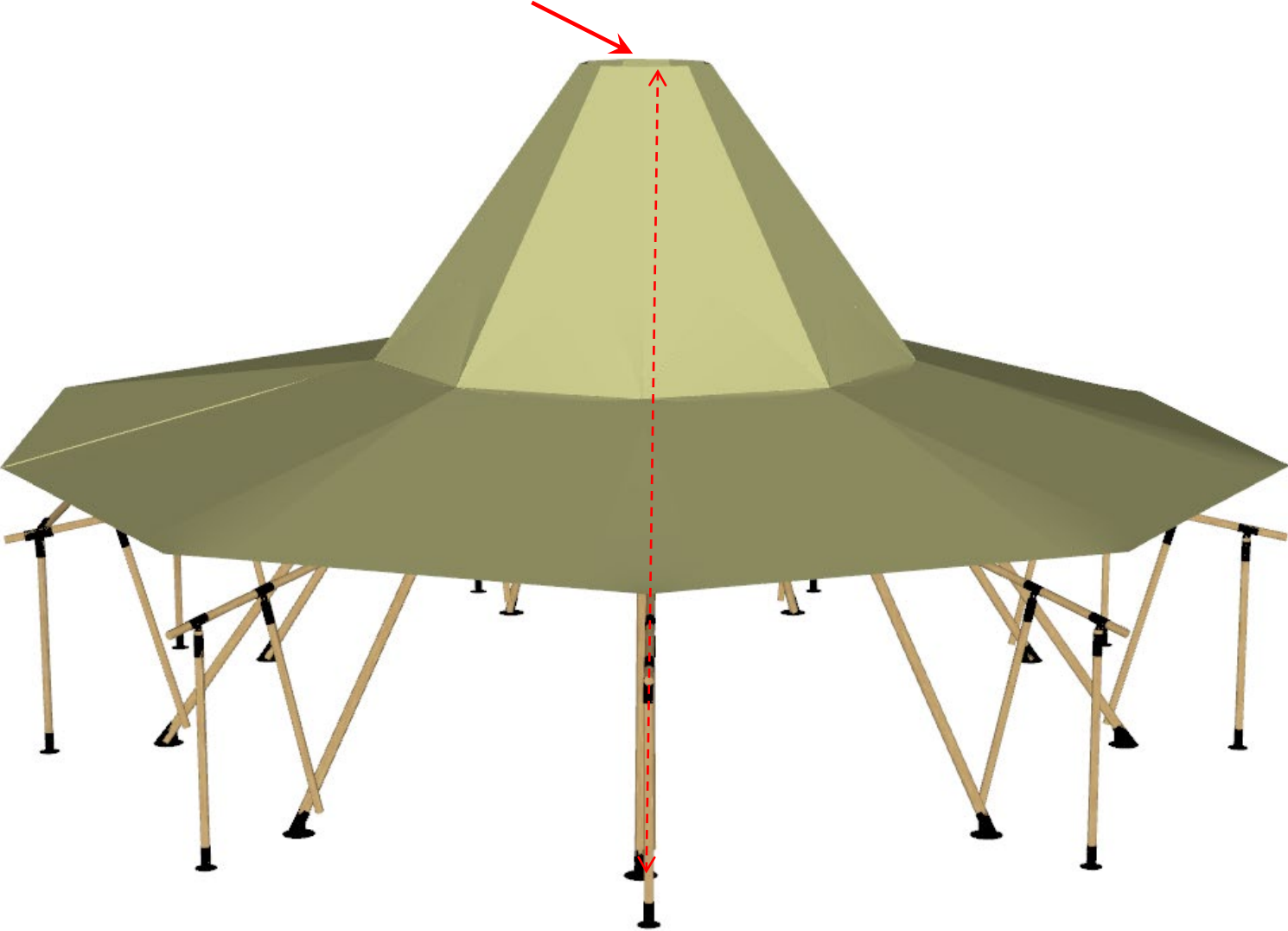

Step 3: Stretch out the cloth, tighten and fix the edge of the cloth with the tighter at the end of 3# poles, and fix the inside with buckle webbing and frame (3# poles); unfold the side panels, assemble the inner top of the side panels with the upper part of the cloth and use 25m length 8# khaki rope to pass through the reserved hole of the side panel and wrap it around and fix it, as shown below:

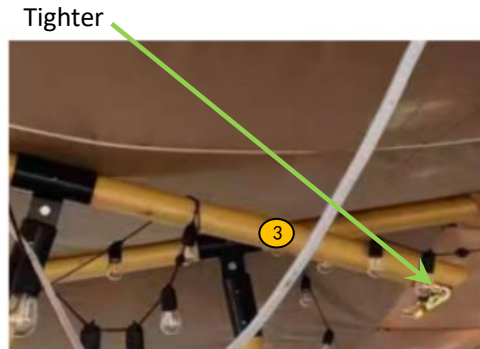

fix the inside with buckle webbing



use 25m length 8# khaki rope to pass through the reserved hole



Step 4: Hang the 8# black rubber band on the top cap (3 in total), pull it to the angled position, and hook it with hook, as shown below:

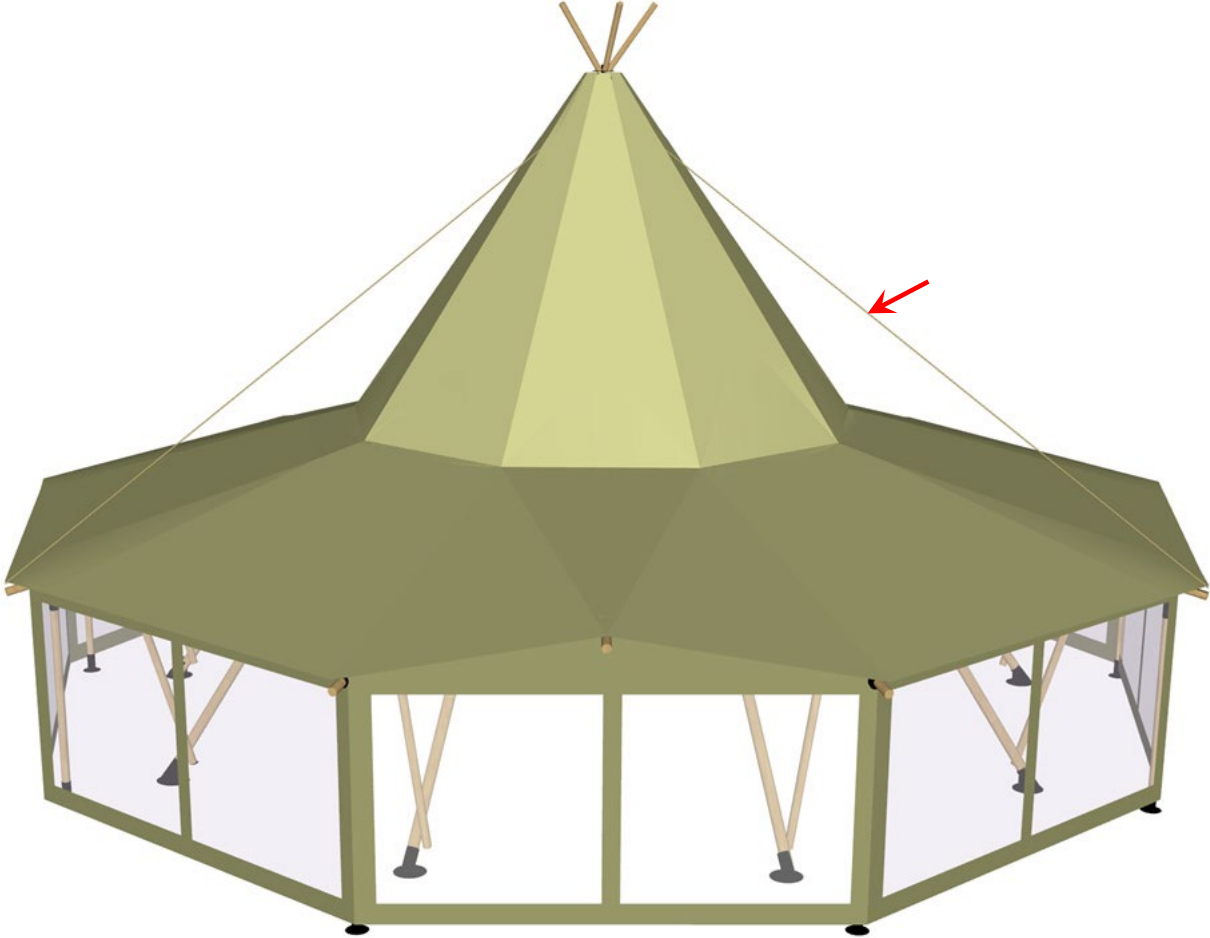

Step 5, adjust 1 pc 5m length 8# khaki rope on the cloth, then tie other 8pcs 5m length 8# khaki ropes, tie one end to the M10 ground anchors, and the other end to the cover cloth strap and fix them, as shown below:

5m length 8# khaki rope

